

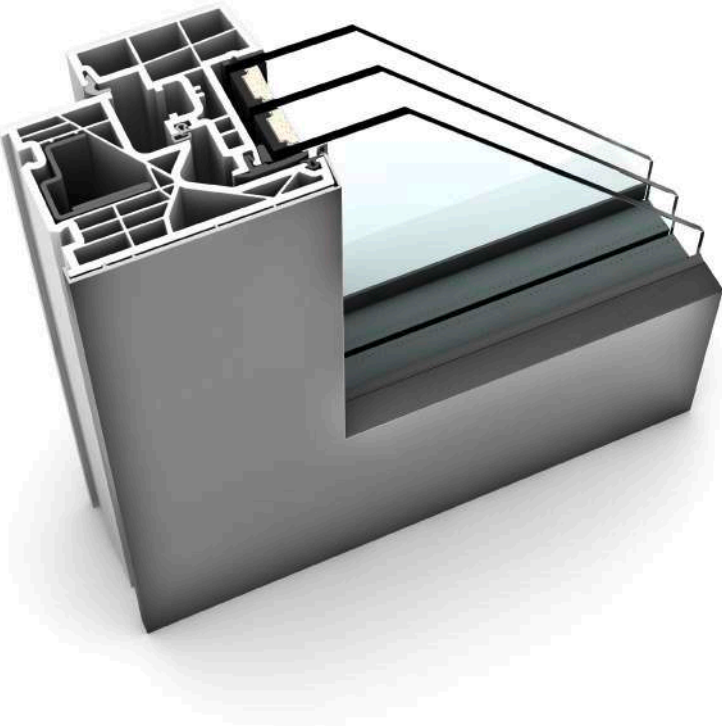





# KF 320 UPVC & UPVC-ALUMINIUM WINDOW



## PROPERTIES

	<b>Thermal insulation</b>	$U_w$ as low as 0.65 W/(m <sup>2</sup> K)
	<b>Sound reduction</b>	up to 45 dB
	<b>Security</b>	RC1N, RC2
	<b>Locking</b>	exposed
	<b>Construction depth</b>	71/74 mm

**I-tec Glazing**

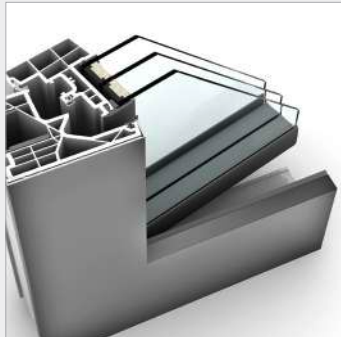
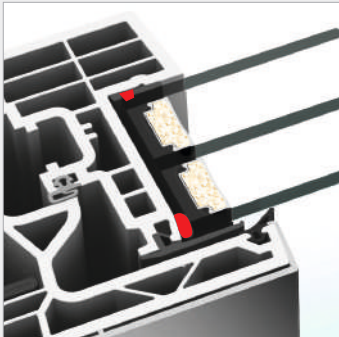
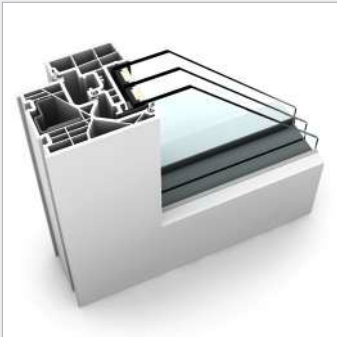

**KF 320**  
 The innovative glass sash of the KF 320 gives the impression of fixed glazing, yet it is still an openable window. The narrow, square-edged window frame emphasizes the reduced architecture of the design style studio in either the classical white UPVC version or with aluminium attachment clad. Three-sided rendering of the frame gives the appearance of almost frameless glass architecture. I-tec glazing ensures excellent stability, thermal insulation and security.

**Sections**

Vertical

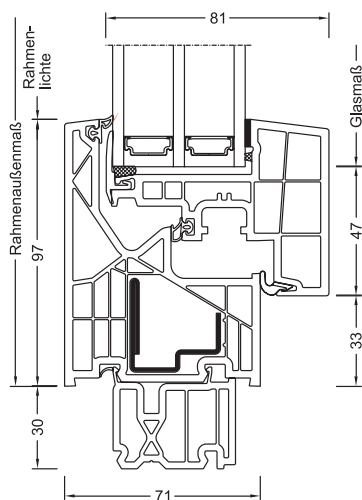

Horizontal

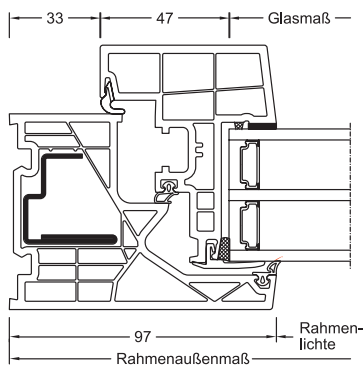

Flying mullion

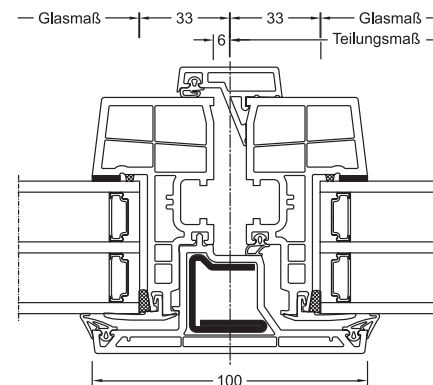

**Values**

System	Glass setup	Glass code	Spacer	Coating	U <sub>g</sub>	g	U <sub>f</sub>	Psi	U <sub>w</sub>	Therm. certificate	R <sub>w</sub>	C	C <sub>tr</sub>	Sound certificate
KF320	4b/18Ar/4/18Ar/b4	3N2	Iso	light	0.5	54%	1.0	0.033	0.72	YES	34	-2	-5	YES
				SolarXPlus	0.5	60%	1.0	0.033	0.72	YES	34	-2	-5	YES
			Alu	light	0.5	54%	1.0	0.076	0.83	YES	34	-2	-5	YES
				SolarXPlus	0.5	60%	1.0	0.076	0.83	YES	34	-2	-5	YES
	6b/18Ar/4/16Ar/b4	33U	Iso	light	0.5	54%	1.0	0.033	0.72	YES	38	-2	-5	YES
				SolarXPlus	0.5	59%	1.0	0.033	0.72	YES	38	-2	-5	YES
			Alu	light	0.5	54%	1.0	0.076	0.83	YES	38	-2	-5	YES
				SolarXPlus	0.5	59%	1.0	0.076	0.83	YES	38	-2	-5	YES
	4b/16Ar/4/15Ar/ b44.2(VSG-S)	34N	Iso	light	0.6	54%	1.0	0.033	0.79	YES	41	-2	-6	YES
				SolarXPlus	0.6	60%	1.0	0.033	0.79	YES	41	-2	-6	YES
			Alu	light	0.6	54%	1.0	0.076	0.90	YES	41	-2	-6	YES
				SolarXPlus	0.6	60%	1.0	0.076	0.90	YES	41	-2	-6	YES
44b.2(VSG-S)/15Ar/ 4/12Ar/ b44.2(VSG-S)	3FH	Iso	light	0.7	50%	1.0	0.033	0.86	YES	45	-2	-5	YES	
			SolarXPlus	0.7	55%	1.0	0.033	0.86	YES	45	-2	-5	YES	
		Alu	light	0.7	50%	1.0	0.076	0.97	YES	45	-2	-5	YES	
			SolarXPlus	0.7	55%	1.0	0.076	0.97	YES	45	-2	-5	YES	